

Revision History

Index

Revision	Date	Comments

01:Revision History and Index	1
02:Function Block Diagram	2
03:S5PV4212 (SYS)/Boot Option	3
04:S5PV4212 (Memory)	4
05:S5PV4212 (Media)	5
06:S5PV4212 (Power)	6
07:NAND/iNAND Flash	7
08:Memory (DDR3)	8
09:Reset/JTAG/SD/Clock	9

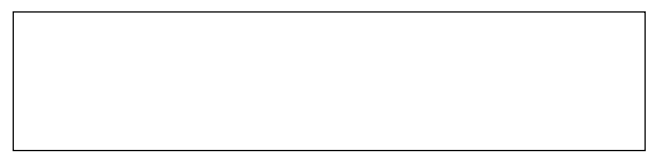
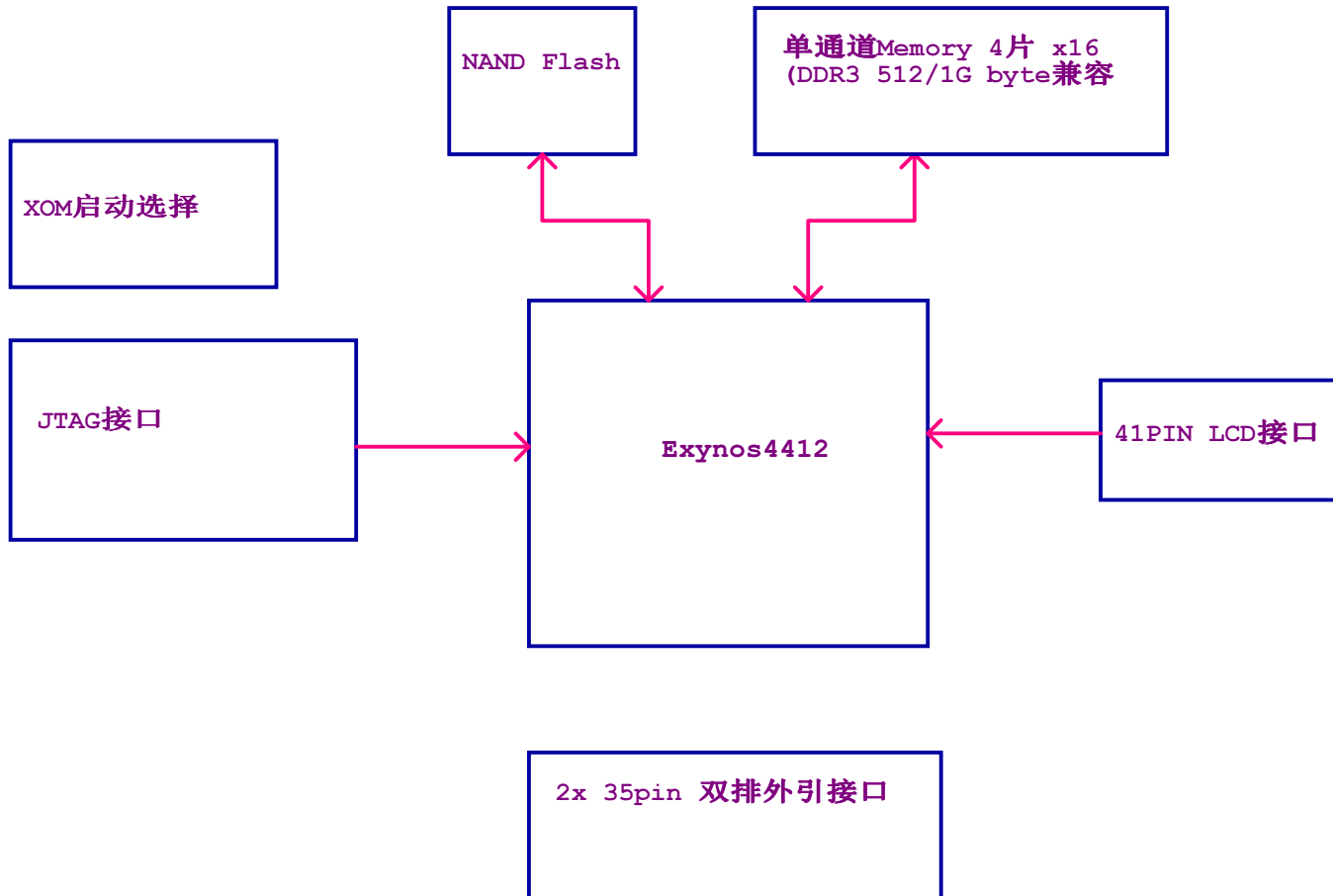

Title		Tiny4412	
Size	A3	Document Number	Rev
Date:	Wednesday, July 10, 2013	Sheet	2 of 14

D

D

C

C

B

B

A

A

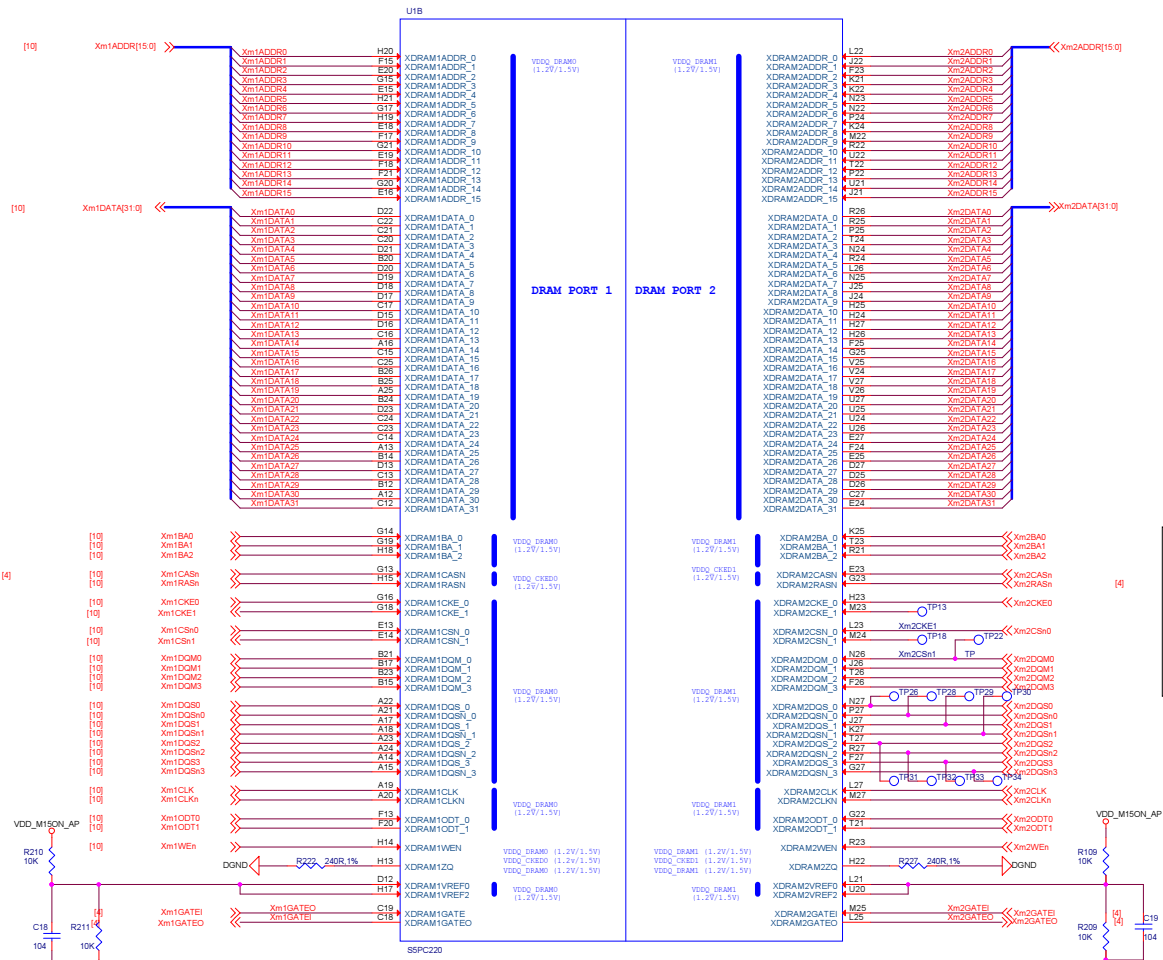

Xm1GATEI << Xm1GATEI Xm1GATEO >> Xm1GATEO

线与clk等长

Xm2GATEO << Xm2GATEO Xm2GATEI >> Xm2GATEI

线与clk等长

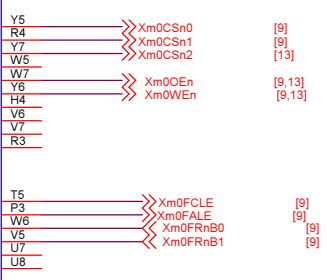
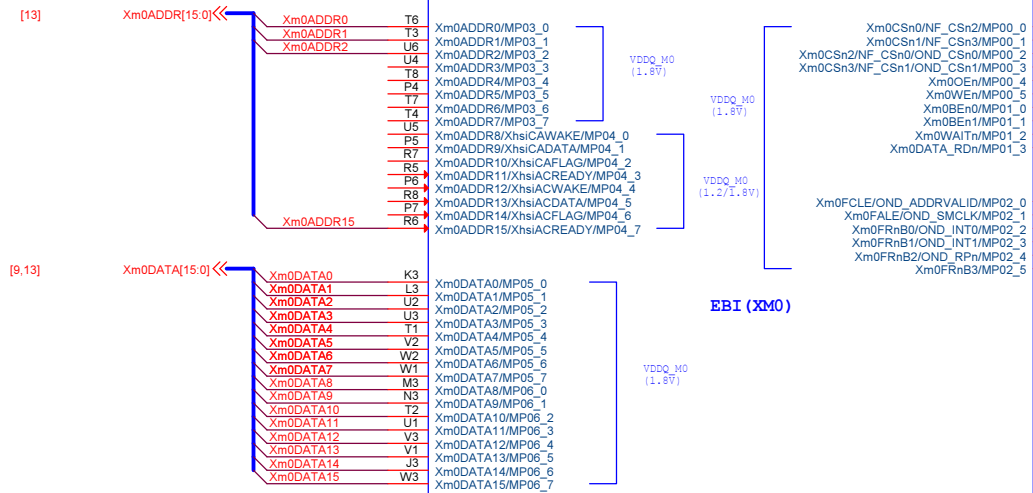

[9]
[9]
[13]
[9,13]
[9,13]
[9]
[9]
[9]

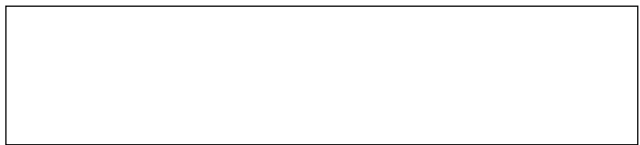
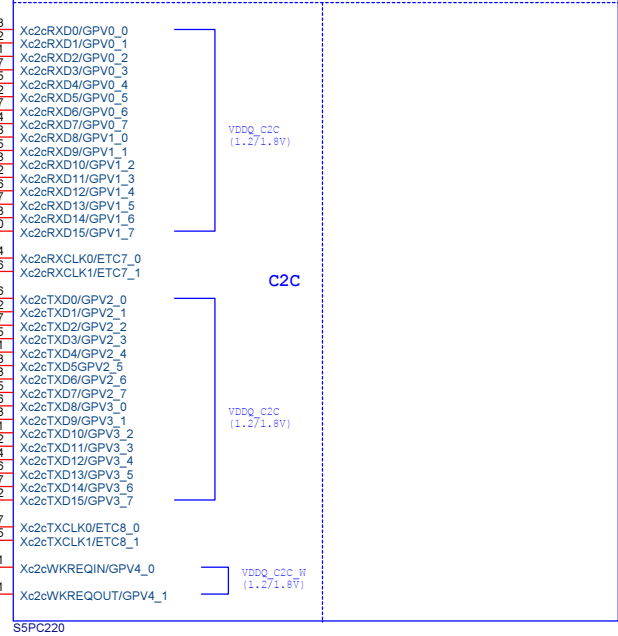

Title		
Tiny4412		
Size	Document Number	Rev
A3	<Doc>	<RevCode>
Date:	Wednesday, July 10, 2013	Sheet 5 of 14

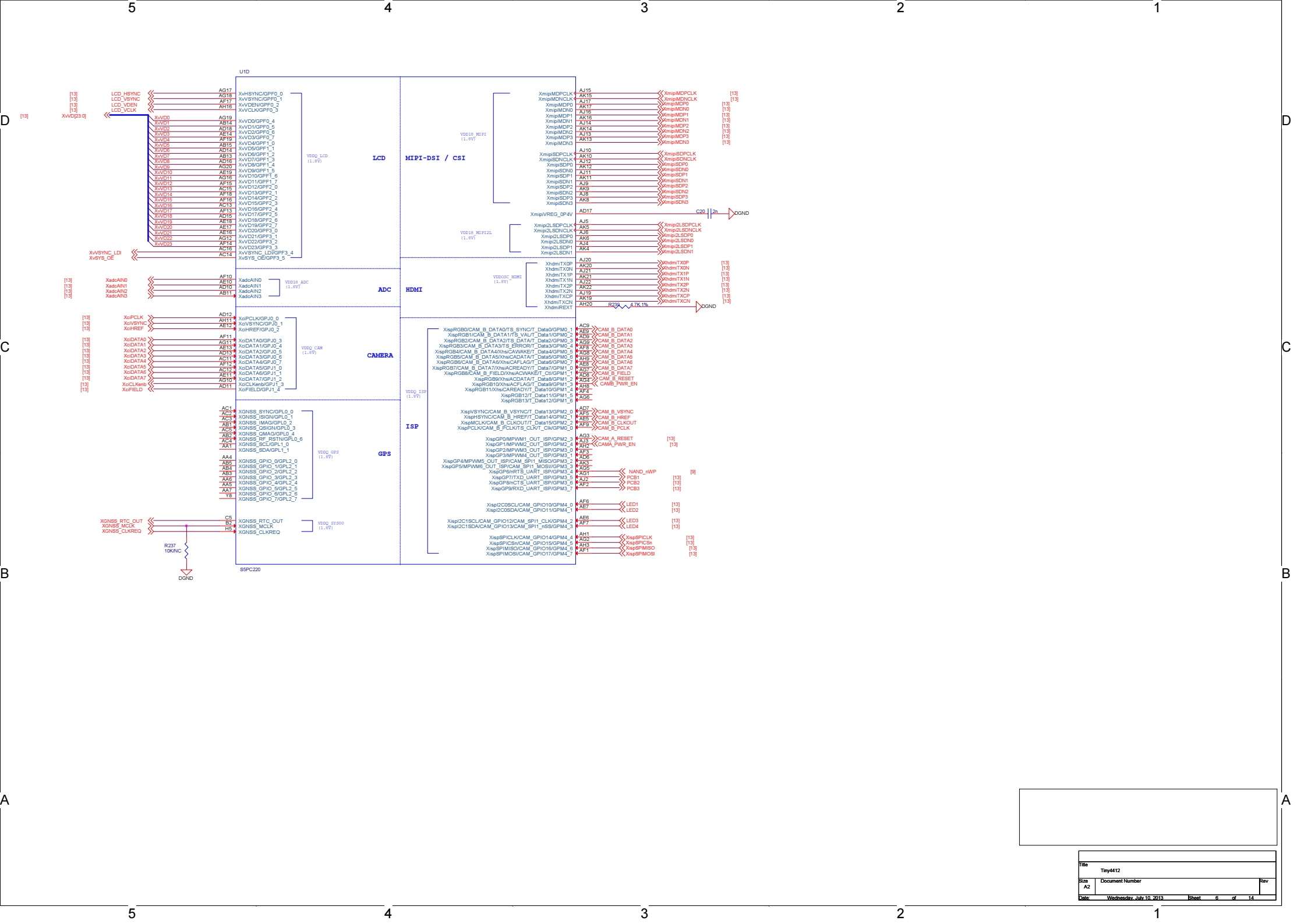

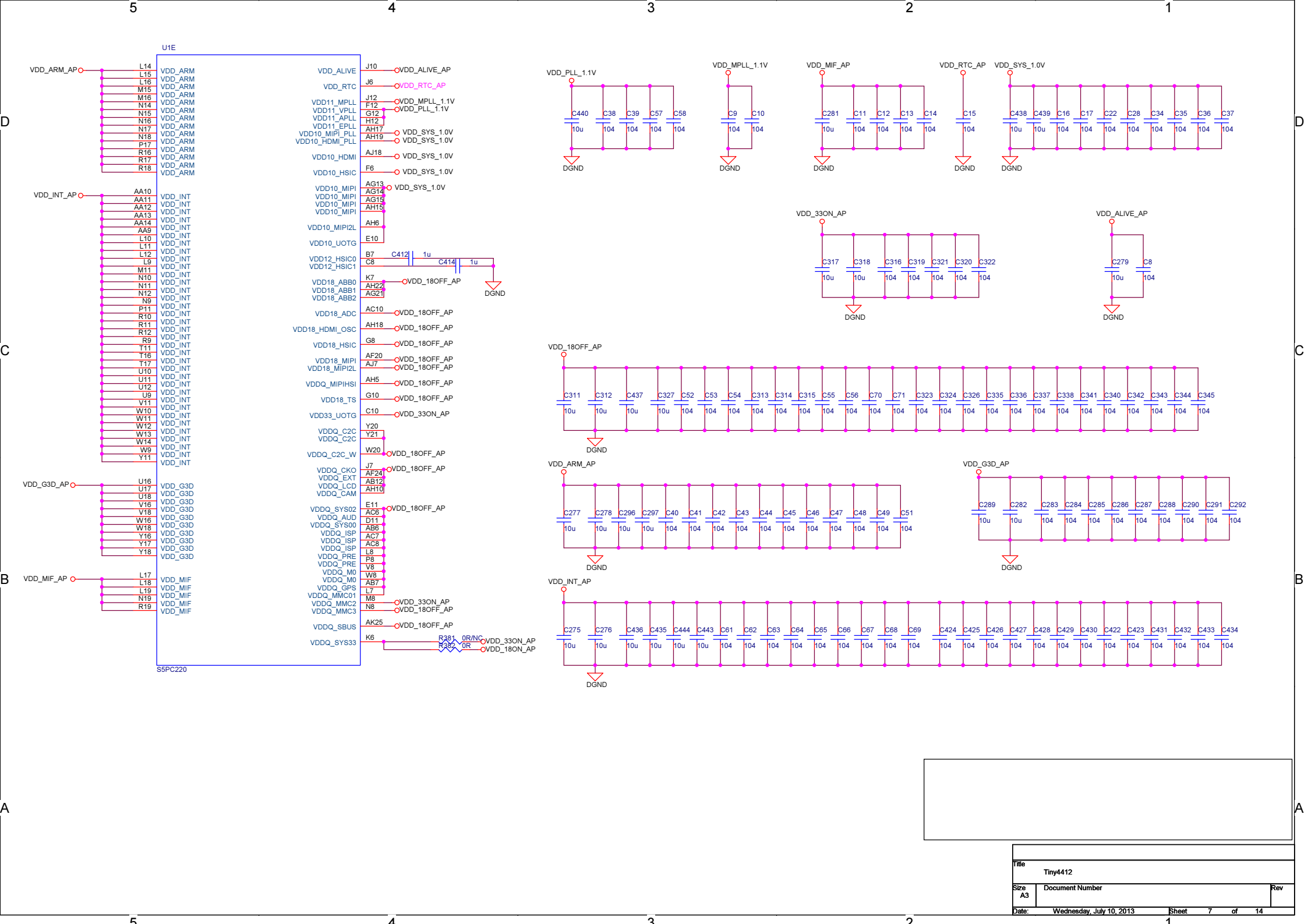

Title		
Tiny4412		
Size	Document Number	Rev
A3		
Date:	Wednesday, July 10, 2013	Sheet 7 of 14

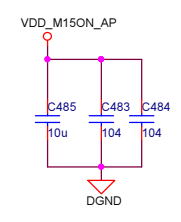
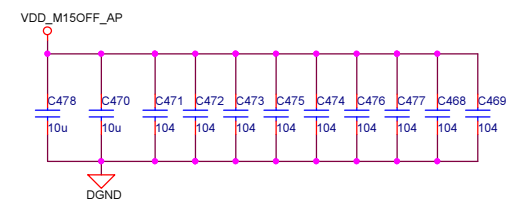
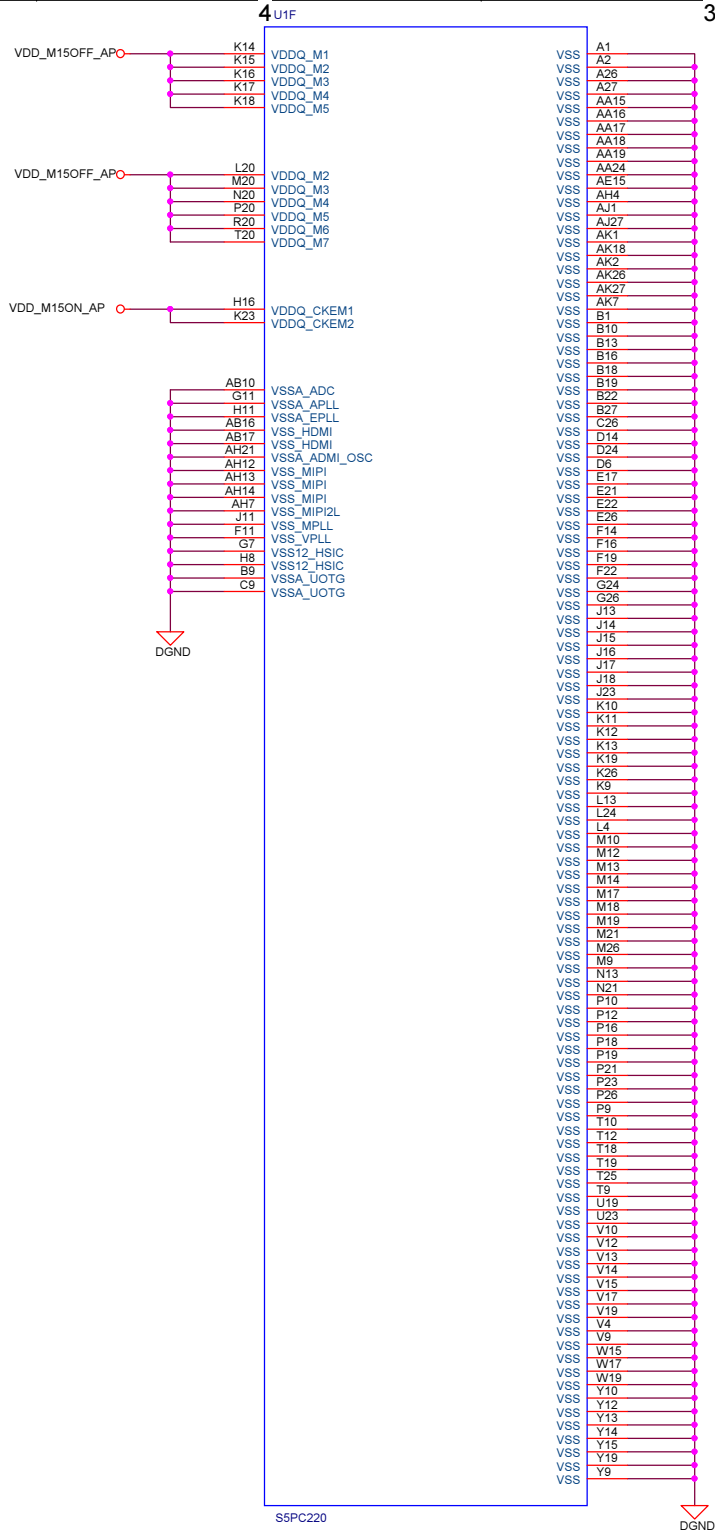

Title		
Tiny4412		
Size	Document Number	Rev
A3	<Doc>	
Date:	Wednesday, July 10, 2013	Sheet 8 of 14

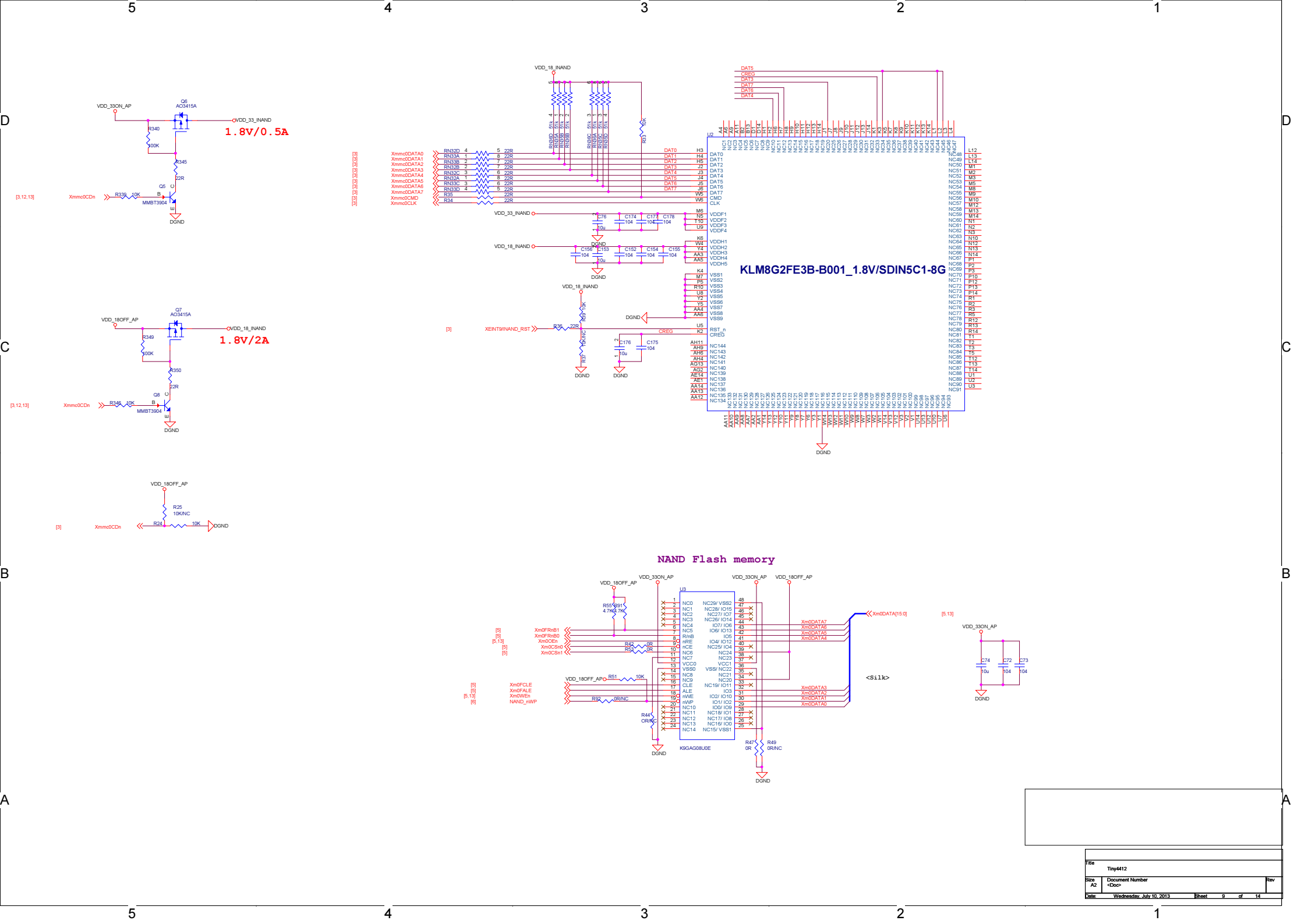

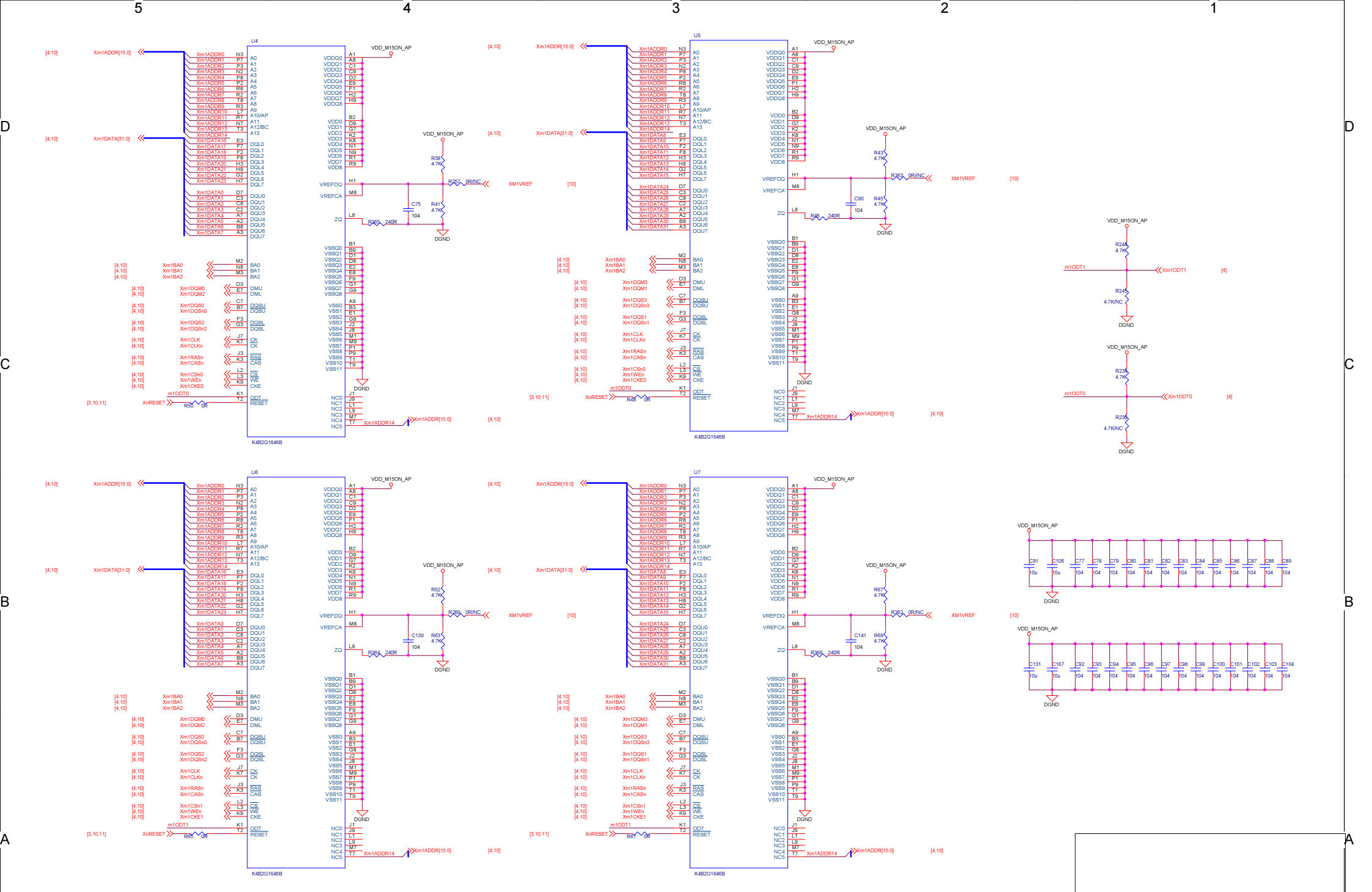

复位电路

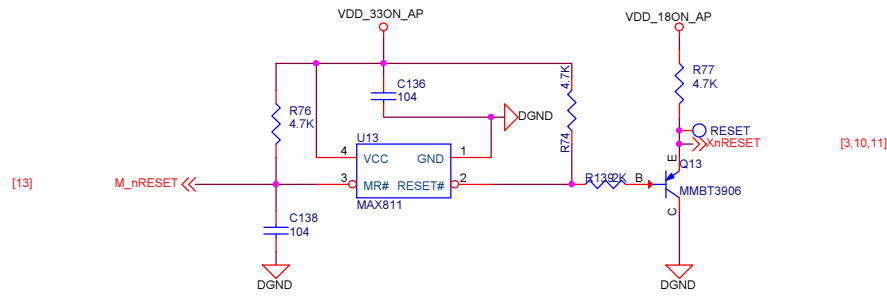

JTAG电路

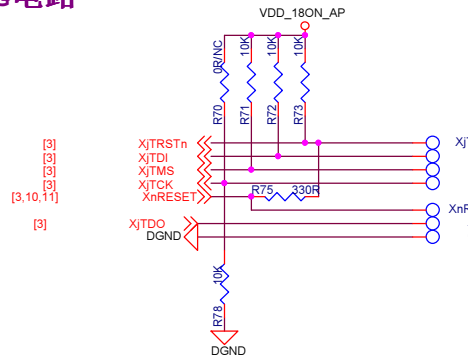

For PLL



For USB HOST

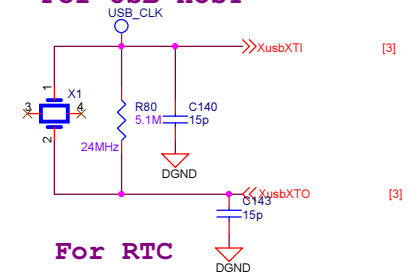

For VEDIO

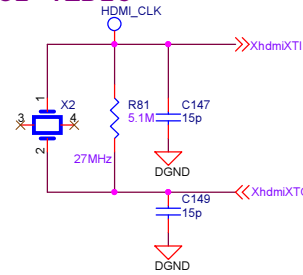

For RTC

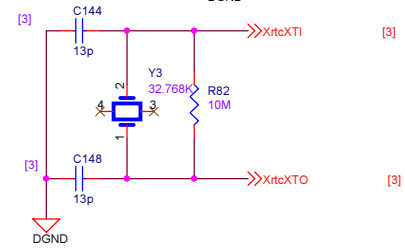

Title		
Tiny4412		
Size	Document Number	Rev
A3		
Date:	Wednesday, July 10, 2013	Sheet 11 of 14

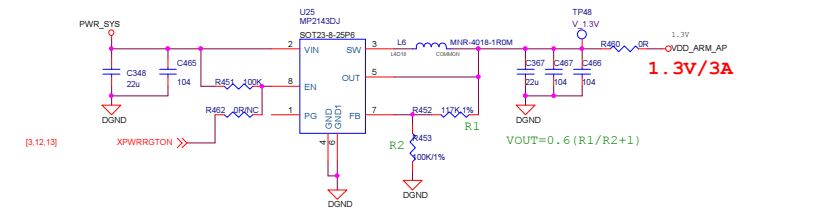
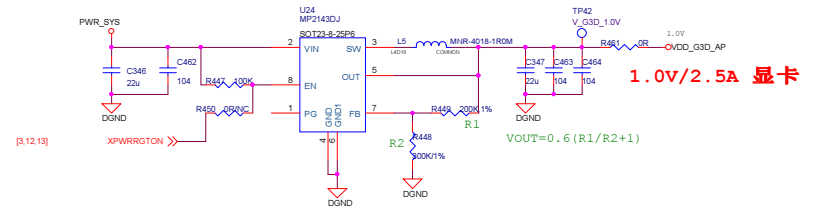
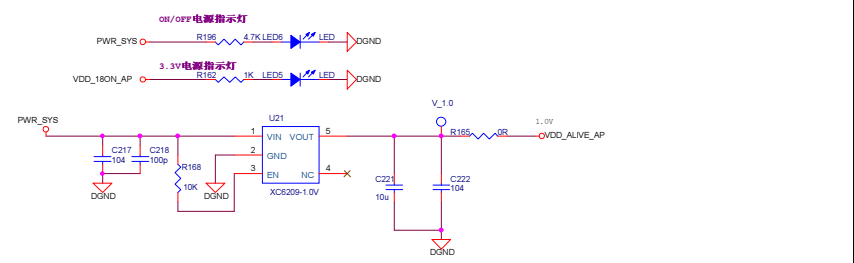
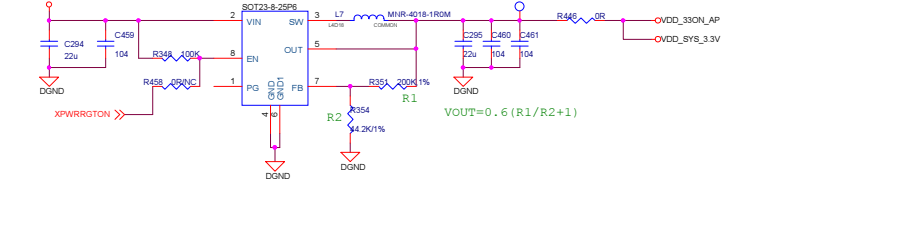
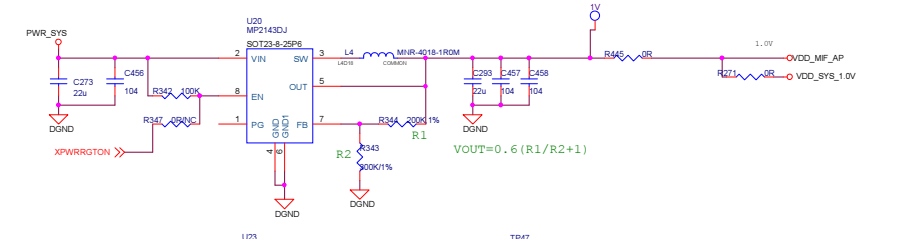
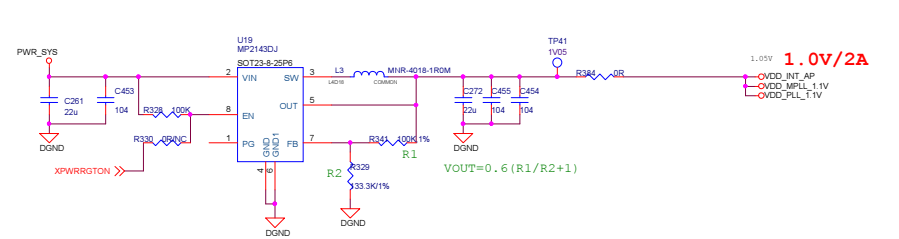
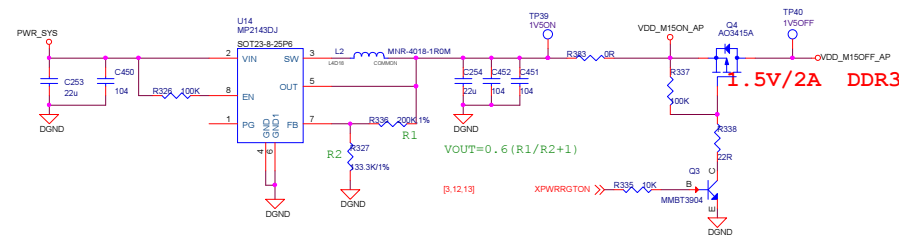
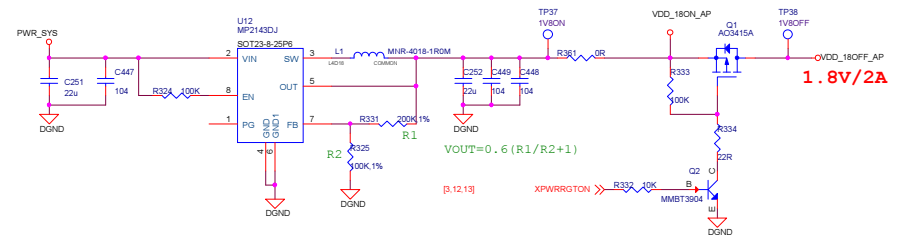

File	Tiny4412	
Size	Document Number	Rev
Date	Wednesday, July 10, 2013	Sheet 12 of 14

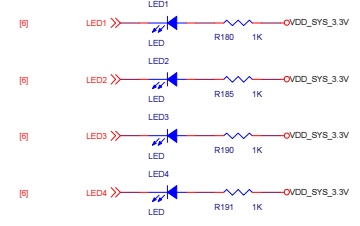
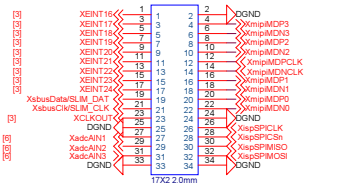
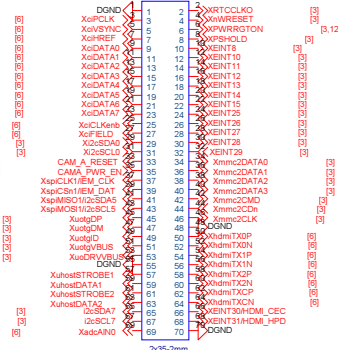
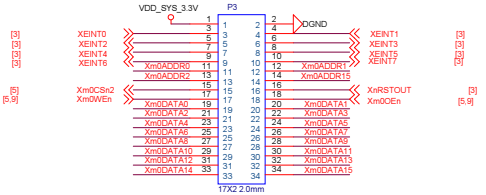
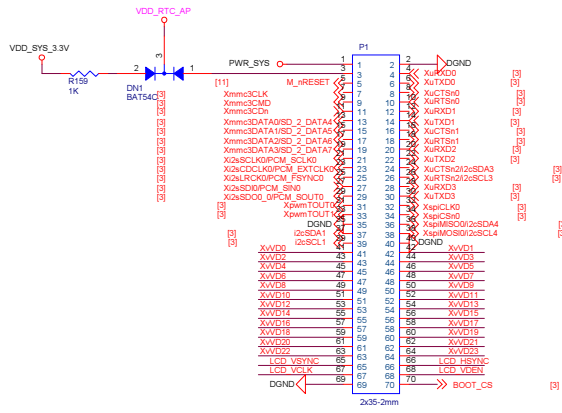
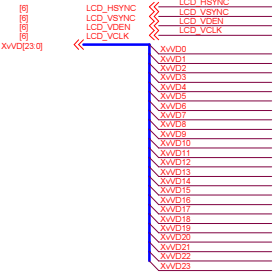
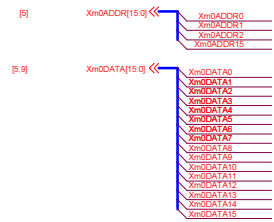

PCB 版本控制

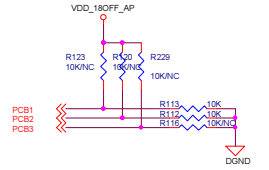

5

4

3

2

1

D

D

ID1	ID2
ID3	ID4
ID6	ID5
定位点	

C

C

B

B

A

A



Title		
Tiny4412		
Size	Document Number	Rev
A3	ID Mark/Fixed Hold	
Date:	Wednesday, July 10, 2013	Sheet 14 of 14
1		