

Title		
Size	Number	Revision
Date: 4-Jul-2012		
File: E:\Mywork\ARM\STM32F051\Schematic\STM32F051R8.dtb		
Sheet of		6

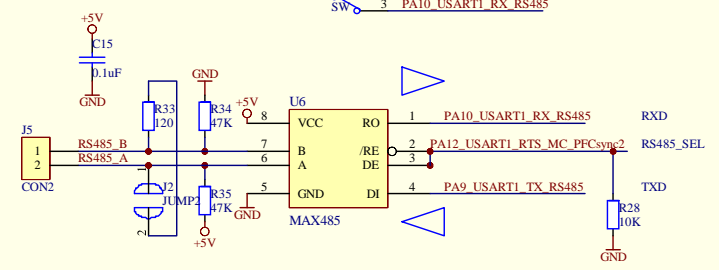

Title		
Size	Number	Revision
B		
Date:	4-Jul-2012	Sheet of
File:	E:\Mywork\ARM\STM32F051\Schematic\STM32F051R8.ddb	3 of 6

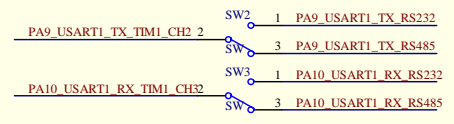
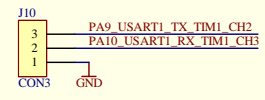
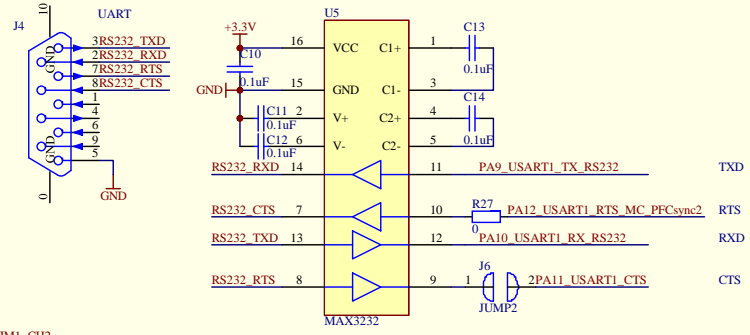
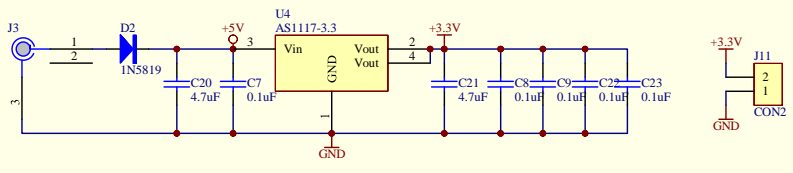
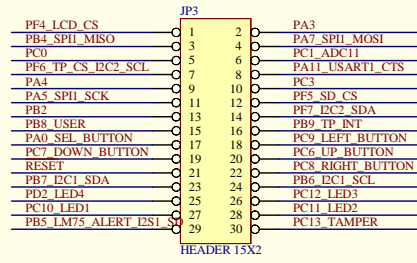
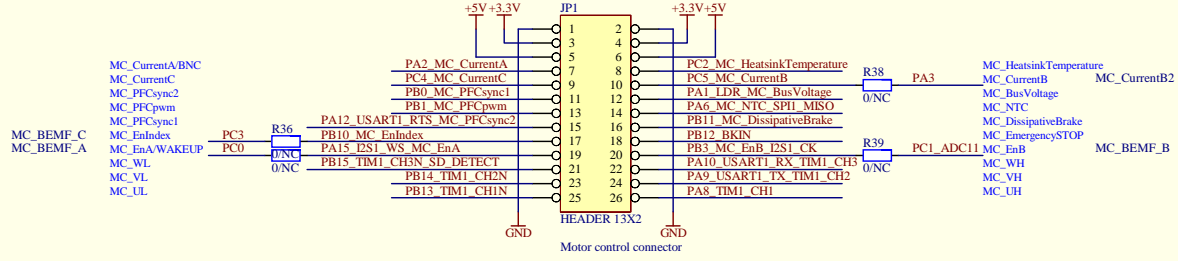

Title		
Size	Number	Revision
B		
Date:	4-Jul-2012	Sheet of
File:	E:\Mywork\ARM\STM32F051\Schematic\STM32F051R8.ddb	3 of 3